

Detta behöver du:  
You will need this:

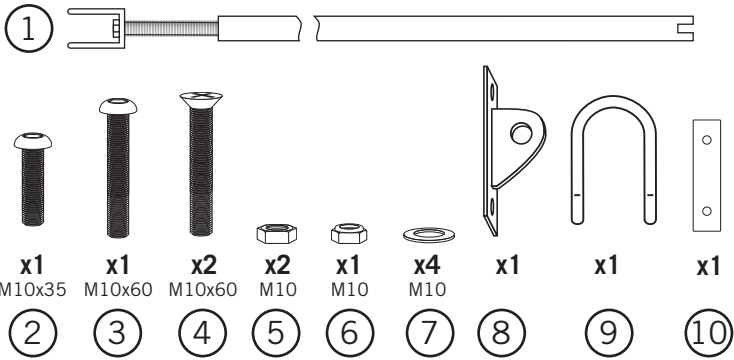

x1  
Ø25, 700-800 mm/  
Ø25, 900-1000 mm

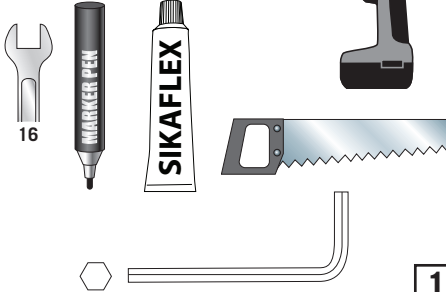
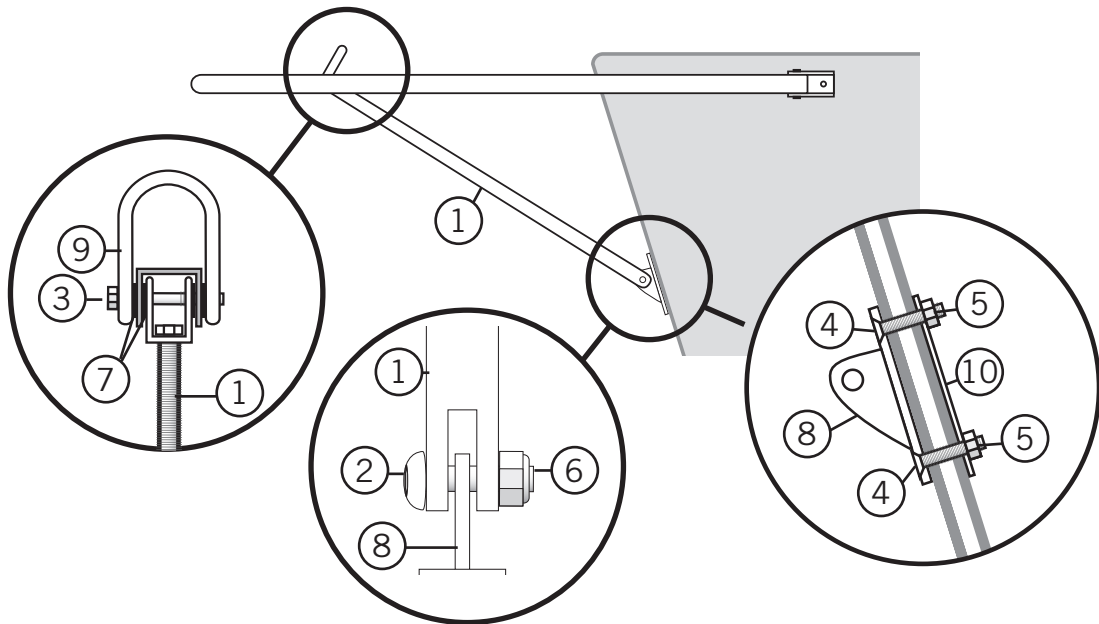

2b

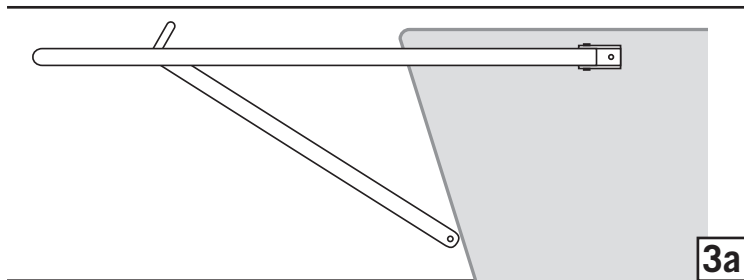

3a

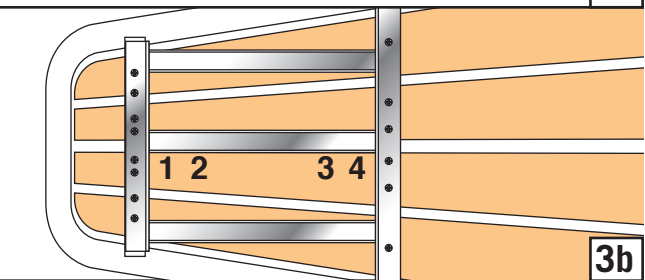

3b

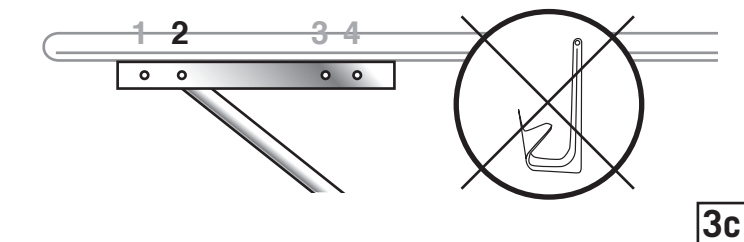

3c

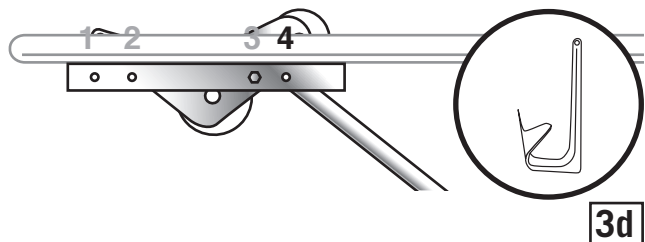

3d

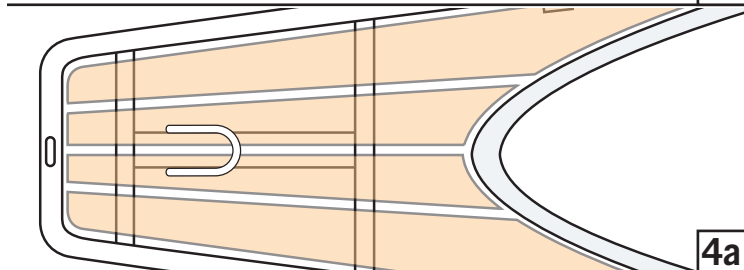

4a

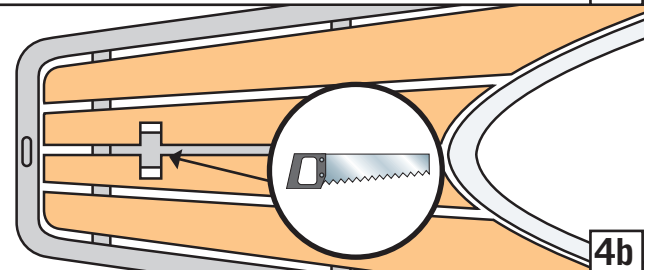

4b

